

CAUTION! Do not use if cable is defective.

- Disconnect the power supply from any defective appliances.
- Factory setting is (NC) Normally Closed
- Guidelines for the electrician; Level of contamination 2; As per EN60730
- When changing from normally closed to normally open, live components are exposed. Therefore, disconnect the power when changing.

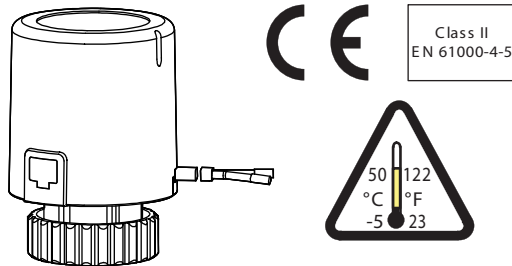

1



2

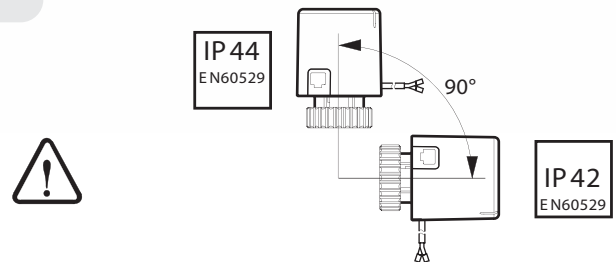

3

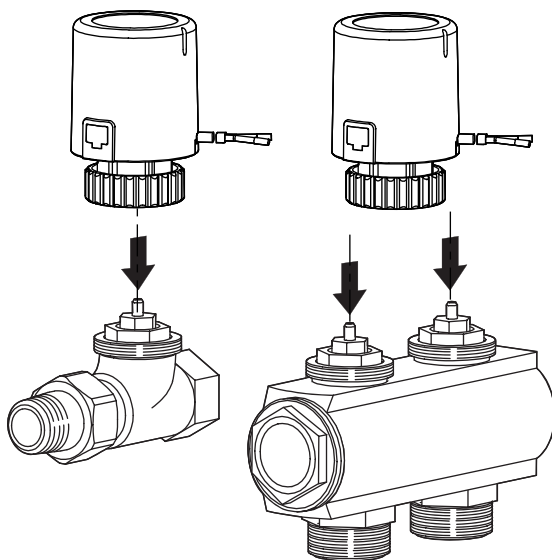

4

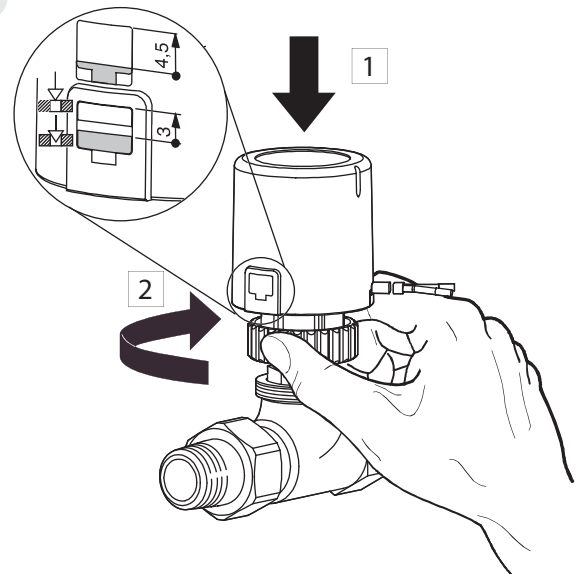

5

TA230 - 230Vac
TA24 - 24Vac

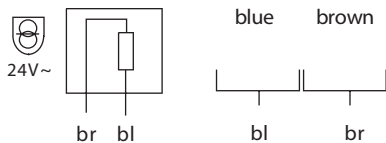

TA24 TA230

U	24 V~	230 V~
t	4,5 min.	3,5 min.
h	3,5 mm	3,5 mm
F	125 N	125 N
P	3 W	2,5 W
I max	250 mA	150 mA

h = stroke

6

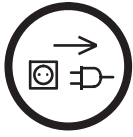

To set to (NO) Normally Open

6.1

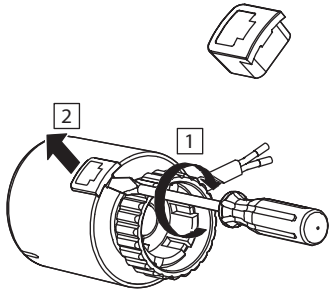

6.2

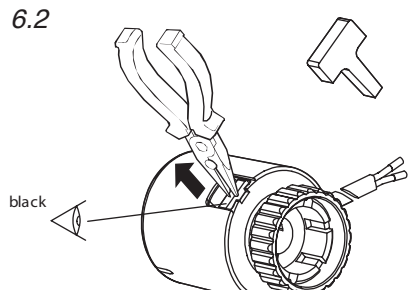

6.3

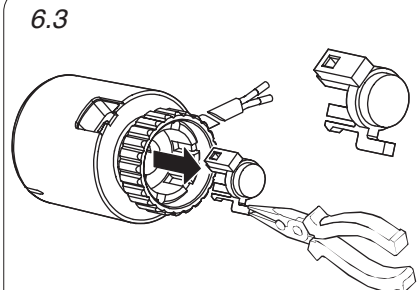

6.4

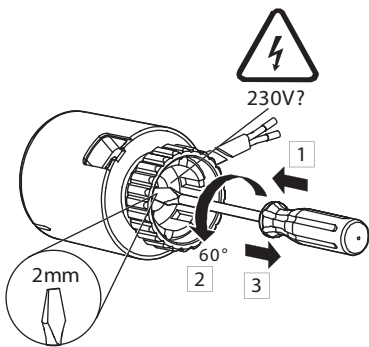

6.5

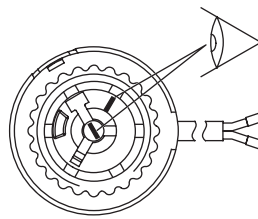

6.6

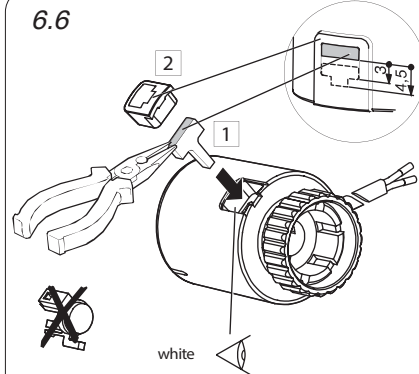

7

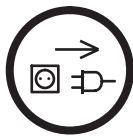

To reset to (NC) Normally Closed

7.1

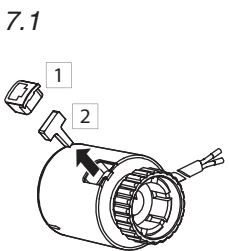

7.2

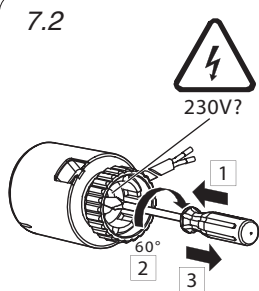

7.3

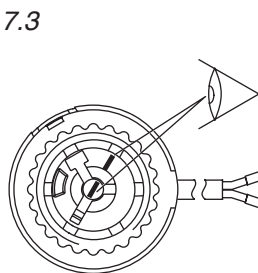

7.4

